

(19) Japanese Patent Office

(12) Unexamined Patent Application Publication (A)

(11) Patent App. No.: H10-302160

(43) Disclosure Bulletin Date: November 13, 1998

| | | | | | |
|-------------------------------------|-----------|-----|--|-------|------|
| (51) Int. Cl.6 | ID Symbol | FI | | | |
| G07G | 1/12 | 321 | G07G | 1/12 | 321P |
| G06G | 17/60 | | G06G | 15/21 | 340A |
| Request for Review: Not Requested | | | Number of Claims: 9 (15 Pages Total) | | |
| (21) Application Number: H09-105521 | | | (71) Applicant: 000002945 | | |
| (22) Filing Date: April 23, 1997 | | | Omron Corporation | | |
| | | | 10 Hanzono Tsuchidocho, Ukyo-ku, Kyoto | | |
| | | | (72) Inventor: Masaki Yamato | | |
| | | | Omron Corporation Facility | | |
| | | | 10 Hanzono Tsuchidocho, Ukyo-ku, Kyoto | | |
| | | | (72) Inventor: Kahei Tanaka | | |
| | | | Omron Corporation Facility | | |
| | | | 10 Hanzono Tsuchidocho, Ukyo-ku, Kyoto | | |
| | | | (74) Representative: Hisao Omori, Attorney | | |

(54) Name of Invention: Transaction Processing System, Terminal Equipment, and Host Device

(57) Abstract

Topic:

To offer a transaction processing system by which, with a single card, there is capability to process a transaction (a credit transaction) with a selected single transaction destination from among a plurality of transaction destinations (card companies).

Solution Means:

In host device 2 there is registered a transaction destination record 21 for each issued ID card. Transaction destination record 21 has internally registered a card company record 30 for each card company. By inserting the ID card into a terminal device 1 at time of a transaction, there is enabled processing of a transaction with a selected card company from among the card companies registered within transaction destination record 21. Accordingly, without carrying a plurality of cards but instead this single ID card, the user is capable of processing a transaction with a selected single card company from among a plurality of card companies.

Claims

Claim 1:

A transaction processing system characterized by connecting a terminal device, established as a means for inputting transaction information through use of a card, with a host device, established as a means for memory setting a plurality of transaction destinations for each said card, by said terminal device possessing a means for transmitting to the host device the input transaction information, and by said host device possessing a transaction destination selection means for selecting a single transaction destination from among a plurality of transaction destinations that are memory set for the card being used at the time of input of the received transaction information, and a means for processing the transaction with the selected transaction destination based on said transaction information.

Claim 2:

A transaction processing system according to Claim 1 characterized by said transaction selection means comprising a means for extracting every transaction destination from among all transaction destinations being memory set, other than any transaction destination that for a prescribed reason is incapable of processing the transaction, and a means for transmitting to the terminal device information about all the extracted transaction destinations, and a means for selecting, from among the transmitted transaction destinations, a transaction destination specified at the terminal device.

Claim 3:

A transaction processing system according to Claim 2 characterized by providing in said terminal device a transaction destination display means for displaying information about all the transaction destinations that have been sent from said host device, and a transaction destination specification means for specifying a single transaction destination from among the transaction destinations displayed by the transaction destination display means.

Claim 4:

A transaction processing system according to Claim 3 characterized by assigning a priority rank to each of the plurality of transaction destinations being memory set in said host device, and by said transaction destination display means displaying in order from the transaction destination information of the highest priority rank.

Claim 5:

A transaction processing system according to any of Claims 1~4 characterized by memory setting credit card companies as said transaction destinations.

Claim 6:

A transaction processing system according to either Claim 3 or 4 characterized by memory setting credit card companies as said transaction destinations, and by said transaction destination display means incorporating a means to display a credit limit amount for each credit card company displayed as a transaction destination.

Claim 7:

A terminal device characterized by being connected to a host device in which is memory set a plurality of transaction destinations for each card, a by providing a transaction information input means for inputting transaction information through use of said card, a transaction information transmission means for transmitting to the host device the transaction information input by said transaction information input means, a transaction destination display means for displaying information about the transaction destinations extracted from among the transaction destinations being memory set in the host device for the card being used at the time of input of said transaction information, and a transaction destination specification means for specifying a single transaction destination from among the transaction destinations displayed by said transaction destination display means.

Claim 8:

A terminal device according to Claim 7 characterized by said transaction destination display means displaying in order from the transaction destination of the highest priority rank.

Claim 9:

A host device characterized by being connected to a terminal device that inputs transaction information through use of a card,
and by providing a transaction information reception means for receiving transaction information from said terminal device, a transaction destination selection means for selecting a single transaction destination from among a plurality of transaction destinations being memory set for the card being used at the time of input of the received transaction information, and a means for processing, based on said transaction information, the transaction with the transaction destination selected by said transaction destination selection means.

Detailed Description of the Invention

[0001]

Technical Field to Which the Invention Belongs

This invention relates to transaction processing systems that process transactions based on transaction information that has been input through use of a card, and to terminal devices and host devices utilized by those transaction processing systems.

[0002]

Former Technology

For some time credit transactions have been performed through the use of credit cards. Recently there has been an increase in the number of customers possessing a plurality of credit cards and thereby contracted with a plurality of credit card companies (hereafter, referred to simply as card companies).

[0003]

Problem the Invention Seeks to Solve

However, customers possessing a plurality of credit cards may at times consider (become anxious about) which credit card to use to process a transaction at the time of processing a transaction at a retail outlet. Accordingly, the customer requires a considerable time for determining which credit card to use. There are also instances in which, after the customer starts transaction processing through use of a particular credit card, the transaction is cancelled for a reason such as the transaction amount exceeding the credit limit amount or the card surpassing its expiration date, and processing of the transaction must be restarted through use of a different credit card. These are problems that hinder smooth execution of transaction processing at the retail outlet.

[0004]

Additionally, the customer may consider carrying a plurality of credit cards to be inconvenient, and therefore service provided to the customer may be unsatisfactory. It is therefore desirable that a system, through use of a single card, be capable of processing a transaction with a selected single card company from among a plurality of card companies.

[0005]

The purpose of this invention is to offer a transaction processing system that, through use of a single card, is capable of transaction processing with a selected single transaction destination from among a plurality of transaction destinations.

[0006]

Furthermore, this invention has as its purpose the offering a transaction processing system that, without carrying a plurality of cards but instead a single card, is capable of processing a transaction with a plurality of credit card companies.

[0007]

This invention also has as its purpose the offering of an terminal device and a host device that are utilized with the above described transaction processing system.

[0008]

Means of Solving the Problem

The transaction processing system of the invention recorded in Claim 1 is characterized by connecting a terminal device, established as a means for inputting transaction information through use of a card, with a host device, established as a means for memory setting a plurality

of transaction destinations for each said card, by said terminal device possessing a means for transmitting to the host device the input transaction information, and by said host device possessing a transaction destination selection means for selecting a single transaction destination from among a plurality of transaction destinations that are memory set for the card being used at the time of input of the received transaction information, and a means for processing the transaction with the selected transaction destination based on said transaction information.

[0009]

With this structure, the terminal device transmits to the host device transaction information that has been input through use of a card. The host device selects a single transaction destination from among a plurality of transaction destinations that have been memory set for the card being used at the time of input of the transaction information. Then, based on the received transaction information, the transaction is processed with the selected transaction destination. Specifically, there is capability, with a single card, to process a transaction with a selected single transaction destination from among a plurality of transaction destinations memory set in the host device for the card. Accordingly, through use of a single card, there is capability to process transactions with a plurality of transaction destinations. Moreover, because the plurality of transaction destinations are memory set in the host device rather than in the card, the memory capacity requirement for the card itself is reduced. This enables manufacturing of the card at reduced cost.

[0010]

The invention recorded in Claim 2 is characterized by said transaction selection means comprising a means for extracting every transaction destination from among all transaction destinations being memory set, other than any transaction destination that for a prescribed reason is incapable of processing the transaction, and a means for transmitting to the terminal device information about all the extracted transaction destinations, and a means for selecting, from among the transmitted transaction destinations, a transaction destination specified at the terminal device.

[0011]

With this structure, the host device extracts every transaction destination from among the transaction destinations being memory set, other than any transaction destination that for a prescribed reason is incapable of processing the transaction, and it transmits these transaction destinations to the terminal device. Then, as the transaction destination for processing the transaction, there is selection of the transaction destination specified at the terminal device. Accordingly, because the host device in advance excludes any transaction destination incapable of the transaction for a prescribed reason, a transaction destination incapable of the transaction for the prescribed reason cannot be specified at the terminal device. This prevents cancellation of started transaction processing based on the prescribed reason, as well as restarting of transaction processing with selection of a different transaction destination. The result is smooth performance of transaction processing.

[0012]

The invention recorded in Claim 3 is characterized by providing in said terminal device a transaction destination display means for displaying information about all the transaction destinations that have been sent from said host device, and a transaction destination specification means for specifying a single transaction destination from among the transaction destinations displayed by the transaction destination display means.

[0013]

Because this structure is arranged to display, by the transaction destination display means, the transaction capable transaction destinations transmitted from the host device, and, from among those displayed, to cause specification of a transaction destination for transaction processing, there is enabled confirmation and specification of a transaction destination at the terminal device.

[0014]

The invention recorded in Claim 4 is characterized by assigning a priority rank to each of the plurality of transaction destinations being memory set in said host device, and by said transaction

destination display means displaying in order from the transaction destination information of the highest priority rank.

[0015]

Because this structure is arranged to display a plurality of transaction destinations in order from the transaction destination of the highest priority rank, there is enabled specification of a transaction destination with evaluation of this display as criteria. Accordingly, there is enabled a degree of shortening of the time related to specifying (selecting) the transaction destination, thereby allowing transaction processing to be processed more smoothly by a comparable degree.

[0016]

The invention recorded in Claim 5 is a structure that sets credit card companies as said transaction destinations. This structure enables transaction processing with a plurality of credit card companies through use of a single card. Accordingly, the customer is not made to carry a plurality of credit cards, and customer service is thereby improved.

[0017]

The invention recorded in Claim 6 is arranged to display a credit limit amount for each credit card company displayed as a transaction destination at the terminal device. This allows the customer to apply suitable criteria at the time of selecting a credit card company at the terminal device. Selection of the credit card company is thereby simplified.

[0018]

The invention recorded in Claim 7 is the terminal device implemented in the transaction processing system recorded in Claim 1, and the invention recorded in Claim 8 is the terminal device implemented in the transaction processing system recorded in Claim 3, and the invention recorded in Claim 9 is the host device implemented in the transaction processing system recorded in Claim 1.

[0019]

Implementation Mode of the Invention

Figure 1 is a drawing that shows the structure of the transaction processing system being an implementation mode of this invention. The transaction processing system of this implementation mode provides terminal device 1 for inputting transaction information through use of a card, and host device 2 connected to terminal device 1. As shown in the drawing, multiple instances of terminal device 1 are connected to host device 2. Furthermore, while not shown in the drawing, host device 2 is also connected to credit card companies (hereafter, referred to simply as card companies) through a public circuit network. As shown in Figure 2, the card is a general purpose magnetic card. From this point, the card is referred to as an ID card. Within magnetic strip 6 of ID card 5 is memory set information such as the card number (hereafter, referred to as ID number) and the effective period of the card.

[0020]

Figure 3 is a drawing that shows the structure of the terminal device. 11 is the CPU, 12 is ROM, and 13 is RAM. 14 is an input component for inputting, by key operation, such as product information for the transaction. 15 is a card reader for reading memory set information from the magnetic strip of the credit card. 16 is a communications component for performing information communications with host device 2. 17 is a display component for performing display processing. 18 is a printer for issuing a receipt on which is printed such as the transaction details.

[0021]

This transaction processing system issues a single ID card 5 to a single customer. As shown in Figure 4 (A), transaction destination file 20 is established in host device 2. Within transaction destination file 20 is registered a transaction destination record 21 issued for each ID card. Transaction destination record 21 provides an ID number memory area 22 for memory setting an ID number, and a card company information memory area 23 for memory setting card company

record 30, shown in Figure 4 (B), that memory sets card company information. Within card company information memory area 23 there can be memory set a plurality of card company record 30. A customer who has received ID card 5 can register a card company record 30 for each possessed credit card. Card company record 30 can be registered by executing a new registration process described hereafter. A registered card company record 30 can be deleted by executing a deletion process described hereafter.

[0022]

Card company record 30 provides company name memory area 31 for memory setting the name of the card company that has issued the corresponding credit card, identification code memory area 32 for memory setting the identification code of the card company, encoding data memory area 33 for memory setting the encoding data for the credit card, first priority rank memory area 34 for memory setting a user established priority rank for the card company, second priority rank memory area 35 for memory setting a host device established priority rank for the card company, effective period memory area 36 for memory setting an effective period for the credit card, and credit limit memory area 37 for memory setting a credit limit amount for the credit card. Furthermore, first priority rank memory area 34 can set a priority rank through a priority rank modification process described hereafter. A default is applied until this priority rank modification process is executed. Host device 2 performs processing to set a priority rank for memory setting to the second priority rank memory area, at new registration of a card company record 30 and at a set prescribed period. As examples, setting of the priority rank by host device 2 can be performed with the following conditions.

(1) The priority rank is made higher to the extent that a card company has a high conversion rate for award points applied to transaction amounts.

(2) The priority rank is made higher to the extent that a card company has been used longer by the customer.

(3) The priority rank is made higher if a card company is in a period of providing special incentives.

(4) The priority rank is made higher to the extent that a card company has a lower usage fee at the time of the transaction.

It is acceptable to establish a priority rank by a single condition of (1) through (4) described above or to establish a priority rank by a combination of multiple conditions. Moreover, it is acceptable to establish a priority rank by utilizing a condition other than (1) through (4) described above.

[0023]

The following section describes in detail the processing of the transaction processing system of this implementation mode. Figure 5 is a flow chart that shows the process of the transaction processing system of this invention. Terminal device 1 remains on standby for ID card 5 to be inserted to card reader 15 (n1). When ID card 5 is inserted, the device reads from ID card 5 card information including the ID number (n2). The device then remains on standby for a key on input component 14 to be operated (n3). On input component 14 there are established such as a new registration key for operating at time of registering a new card company record 30, a deletion key for operating at time of deleting a registered card company record 30, a priority rank modification key for operating at time of modifying the priority rank of a registered card company record 30, and a transaction key for operating at time of processing a transaction. At detection of a key operation at n3, terminal device 1 judges whether the operated key was the new registration key, the deletion key, the priority rank modification key, the transaction key, or another key (n4~n7). At operation of the new registration key there is performing of the new registration process (n8), at operation of the deletion key there is performing of the deletion process (n9), at operation of the priority rank modification key there is performing of the priority rank modification process (n10), at operation of the transaction key there is performing of the transaction process (n11), and at operation of another key there is performing of the corresponding process (another process) (n12).

[0024]

The following section first describes in detail the new registration process of n8. Figure 6 is a flow chart that shows the new registration process. Terminal device 1 remains on standby for insertion to card reader 15 of the credit card to be newly registered (n21). The customer inserts to card reader 15 the credit card to be newly registered. At insertion of the credit card to card reader 15, terminal device 1 reads the information memory set on the inserted credit card (n22). The information read at this time includes such as the identification code of the credit card company, encoding data, and the effective period. The device forms new registration data corresponding to the ID number read at n2 and the information read at n22 (n23), and transmits the data from communications component 16 to host device 2 (n24).

[0025]

At reception of the new registration data (n31), host device 2 creates a new card company record 30 based on the new registration data (n32). Based on the new registration data, the ID number is read (n33). Subsequently, within transaction destination file 20, the card company record 30 created at n32 is added for registration to card company information memory area 23 of the transaction destination record 21 registered under the ID number read by n33 (n34). A notification of registration completion is then transmitted to terminal device 1 (n35).

[0026]

When terminal device 1 receives the notification of registration completion from host device 2 (n25), it remains on standby in the event that another credit card is to be newly registered (n26). If the customer inputs that there is another credit card to be newly registered, the process returns to n21 and repeats the steps described above. If the customer inputs that there is not another credit card to be newly registered, the process is terminated.

[0027]

In this way, the customer is able to register with host device 2 a card company record 30 for each credit card possessed by the customer. Furthermore, as described in detail hereafter, by

registering a card company record 30, there is provided capability to process with the corresponding card company a credit transaction through use of ID card 5 (without using the credit card issued by the corresponding card company). Accordingly, performing multiple registration of instances of card company record 30 enables processing of credit transactions with a plurality of card companies through use of ID card 5. Specifically, without carrying a plurality of credit cards but instead carrying only ID card 5, there is capability to process a credit transaction with a plurality of card companies.

[0028]

The following section subsequently describes the deletion process related to n9. Figure 7 is a flow chart that shows the deletion process. Terminal device 1 remains on standby for insertion to card reader 15 of a credit card (n41). The customer inserts the credit card that was used at the time of newly registering the card company record 30 that is desired to be deleted. At insertion of the credit card to card reader 15, terminal device 1 reads the information memory set on the inserted credit card (n42). The information read at this time includes such as the identification code of the credit card company, encoding data, and the effective period. The device forms deletion data corresponding to the ID number read at n2 and the information read at n42 (n43), and transmits the data from communications component 16 to host device 2 (n44).

[0029]

At reception of the new deletion data (n51) from terminal device 1, host device 2 reads the ID number and card company identification code from the deletion data (n51 and n52). The host device then reads from transaction destination file 20 the transaction destination record 21 being registered by the ID number read at n52, and it deletes the corresponding card company record 30 from among the instances of card company record 30 memory set in card company information memory area 23 of this transaction destination record 21 (n54). A notification of deletion completion is then transmitted to terminal device 1 (n55).

[0030]

When terminal device 1 receives the notification of deletion completion from host device 2 (n45), it remains on standby in the event that another card company is to be deleted (n46). If the customer inputs that there is another card company to be deleted, the process returns to n41 and repeats the steps described above. If the customer inputs that there is not another card company to be deleted, the process is terminated.

[0031]

In this way, a customer is able to delete an unneeded card company record 30 with a simple operation. Moreover, it is acceptable to arrange for host device 2 to automatically delete a card company record 30 for which there has been expiration of the effective period memory set in effective period memory area 36.

[0032]

The following section describes the priority rank modification process. Figure 8 is a flow chart that shows the priority rank modification process. Terminal device 1 forms a priority rank modification request that includes the ID number read at n2 (n61) and transmits the request to host device 2 (n62).

[0033]

At reception of the priority rank modification request from terminal device 1 (n71), host device 2 reads the ID number from the received request (n72). The host device then retrieves from transaction destination file 20 the transaction destination record 21 that corresponds to the read ID number, and it transmits to terminal device 1, as transaction destination information, all of the card company names for which instances of card company record 30 are memory set in the retrieved transaction destination record 21 (n73).

[0034]

At reception of the transaction destination information (n63), terminal device 1 displays in

display component 17 all of the card company names included in the transaction destination information (n64). Figure 9 is a diagram that shows a table format example of the display component at this time. Each card company name and its current priority rank is displayed within display component 17. At this point, the customer shifts the cursor to the location of the priority rank being displayed for the card company for which there is desire to modify the priority rank, and the customer operates a numerical key pad established on input device 14 to input the modification priority rank. Terminal device 1 continues to receive from the customer input for priority rank settings until operation of the termination key (n65 and n66). In Figure 9, the cursor is in the position for inputting a priority rank for ABC card company. Operating the key pad at this time will input a priority rank for ABC card company. The customer completes input of priority ranks for the various card companies by pressing the termination key. When input of priority rank settings is completed (when the termination key is pressed), the terminal device forms priority rank information corresponding to the priority rank that has been input for each card company (n67) and transmits that information to host device 2 (n68).

[0035]

At reception of the priority rank information from terminal device 1 (n74), host device 2 sets the priority rank in first priority rank information memory area 34 for each instance of card company record 30, which is recorded in the corresponding transaction destination record 21 (n75). Host device 2 then notifies host device 2 of priority rank setting completion (n76). When terminal device 1 receives the priority rank setting completion notification from host device 2, it terminates the process (n69).

[0036]

The following section describes transaction processing. Figure 10 is a flow chart that shows transaction processing. Terminal device 1 receives input of transaction information that includes such as the identification code (product identification code) of the product undergoing transaction (n81). The terminal device then transmits to host device 2 the transaction information, including the ID number read at n2 (n82).

[0037]

At reception of the transaction information from terminal device 1 (n91), host device 2 reads the ID number from the transaction information (n92). Host device 2 retrieves the transaction destination record 21 that corresponds to this ID, and from the instances of card company record 30 registered in retrieved transaction destination record 21 it selects a single card company record 30 (n93). The card company corresponding to the card company record 30 selected at this point becomes the card company for processing the transaction.

[0038]

The following describes in detail the processing of host device 2 that selects the card company for processing the transaction. Figure 11 is a flow chart that shows the processing that selects the card company for processing the transaction. Host device 2 checks whether or not first priority rank memory area 34 of the instances of card company record 30 are in the default condition (n101). Specifically, this checks whether or not priority ranks for the card companies have been set by the customer. If priority ranks have not been set by the customer, the process selects the card company with the highest priority rank memory set in second priority rank memory area 35 (n102). The process then judges whether or not the credit limit amount of the card company is below the transaction amount for the transaction currently being processed (n103). If the transaction amount exceeds the credit limit amount, the process selects the card company of the next highest priority rank memory set in second priority rank memory area 35 (n104) and then returns to n103. When determination is made at n103 that the transaction amount is at or below the credit limit amount, the process checks whether or not the effective period has expired (n105), and if the effective period has expired the process returns to n104. If at n105 the effective period has not expired, the process selects the card company as the transaction destination card company (n107). Moreover, when priority ranks have been set by the customer, the process executes processing steps identical to n103~106 described above while utilizing the priority ranks memory set in first priority rank memory area 34 (n108~111).

[0039]

In this way, host device 2 does not select as the transaction destination card company a card company for which the credit limit amount is exceeded by the transaction amount nor a card company for which the effective period has expired. Accordingly, there is no potential for disapproval of the transaction for these reasons.

[0040]

At completion of selection of the card company for processing the transaction, host device 2 forms query information for the card company, based on the encoding data memory set in card company record 30 for the card company and on the transaction information received at n91 (n94). The device then transmits the formed query information to the card company selected at n93 (n95). The card company judges whether or not to approve the transaction, based on the query information received, and transmits the result to host device 2. When host device 2 receives the query result from the card company (n96), it forwards the result to terminal device 1 (n97).

[0041]

When terminal device 1 receives the query result from host device 2 (n83), it judges whether or not the transaction has been approved (n84). If the transaction has not been approved, the terminal device executes transaction cancellation processing to cancel the transaction, and then terminates the process (n85). If the transaction has been approved, the device executes settlement processing such as issuing a transaction receipt that has printed the transaction details with printer 18 (n86). The transaction is one that has not been disapproved for previously described reason of effective period expiration or the transaction amount exceeding the credit limit amount, nor is it one that has been disapproved for another reason.

[0042]

As described above, with the transaction processing system of this implementation mode, by registering a plurality of card company record 30 in transaction destination record 21, there is enabled processing of transactions with a plurality of card companies through use of ID card 5.

Specifically, the customer does not carry a plurality of credit cards but instead only carries a single ID card 5. Accordingly, there is the effect of enabling elimination of the inconvenience of the customer carrying a plurality of credit cards, and thereby enabled improvement of customer service. Additionally, because host device 2 selects as the transaction destination card company a card company for which the effective period has not expired and for which the credit limit amount is not exceeded by the transaction amount, there is no disapproval of the transaction for those reasons. This enables reduction of the generation of disapproved transactions and allows transaction processing to be performed smoothly. Moreover, because host device 2 automatically selects a card company as transaction destination, there is no need for the customer to consider which transaction destination card company to use. This enables shortening of time during which a company is selected as the transaction destination and allows transaction processing to be performed more smoothly. Furthermore, with priority ranks set in advance by the customer, there is caused selection of a card company preferred by the customer as the transaction destination.

[0043]

The following section describes a transaction processing system according to another implementation mode of this invention. The point of difference between this implementation mode and the previously described implementation mode is the process for selecting a card company for processing the transaction at time of transaction processing (n93 and the process shown in Figure 11). Figure 12 shows the process for selecting a card company according to the transaction processing system of this implementation mode. From among the instances of card company record 30 memory set in card company information memory area 23, host device 2 extracts all card companies for which neither the effective period is expired nor the credit limit amount exceeded by the transaction amount (n121 [original text mismarked as n111]). The host device then transmits to terminal device 1 the card companies extracted by n121, in the order of highest priority rank memory set in first priority rank memory area 34 (n122 [original text mismarked as n112]). When first priority rank memory area 34 is in the default condition, the host device transmits the card companies extracted by n121 in the order of highest priority rank memory set in second priority rank memory area 35. At this time, host device 2 also transmits the credit limit amount for each card company.

[0044]

In display component 17, terminal device 1 displays the card companies in the order transmitted from host device 2 (n131 [original text mismarked as n121]). Specifically, display component 17 displays the card companies in order from the highest priority rank. The credit limit amount for each card company is also displayed at this time. Figure 13 shows with a table format example display component 17 in the described condition. From among the card companies displayed, the customer specifies a card company that the customer prefers as the transaction destination. Specifying of the card company is performed by aligning the cursor to the desired card company and then operating a prescribed key. With the display shown in Figure 13, the ABC card company will be specified at operation of the prescribed key. When a card company has been specified (n132 [original text mismarked as n122]), terminal device 1 transmits to host device 2, as the selection result, the identification code of the specified card company (n133 [original text mismarked as n123]).

[0045]

When the selection result from terminal device 1 is received (n123 [original text mismarked as n113]), host device 2 reads the customer specified card company from the selection result and selects that card company as the transaction destination (n124 [original text mismarked as n114]).

[0046]

Other processing is executed identically to that of the previously described implementation mode, and therefore a description is omitted.

[0047]

As described above, with the transaction processing system according to this implementation mode, host device 2 extracts all card companies for which neither the effective period is expired nor the credit limit amount exceeded by the transaction amount, and the customer caused to

specify from among these a card company as the transaction destination, and therefore a card company not preferred by the customer is not selected as the transaction destination. Additionally, at the time of causing the customer to select a card company for processing the transaction, the credit limit amount for each card company is also displayed, thereby enabling the customer to apply the information as criteria when selecting a card company, and thereby shortening the time required for the customer to specify a card company as the transaction destination. This enables smooth processing of the transaction.

[0048]

Furthermore, it is acceptable to establish a function to print, on the surface of ID card 5 having been inserted to terminal device 1, the names of credit card companies capable of executing the transaction. Doing so would enable the customer to easily determine credit card companies for which registration in instances of card company record 30 have been forgotten. This further improves customer service.

[0049]

For the two implementation modes described above, It is also acceptable to establish terminal device 1 within the retail outlet in a way that allows free operation by the customer, thereby allowing the customer to freely perform in advance the described new registration processing, deletion processing, and priority rank modification processing. Such a terminal would not require the described function for transaction processing. Arranging in this way would have the effect of allowing the customer to perform new registration processing, deletion processing, and priority rank modification processing without the interaction of others, thereby reducing obligations for interaction from the retail outlet side.

[0050]

Effect of the Invention

As described above, by use of this invention there is enabled, with a single card, processing of a

transaction with a single transaction destination selected from among a plurality of transaction destinations memory set for the card in a host device. This enables processing of transactions with a plurality of transaction destinations through use of a single card. In addition, because the plurality of transaction destinations are memory set in the host device rather than in the card, the memory capacity requirement for the card itself is reduced. This enables manufacturing of the card at reduced cost.

[0051]

Additionally, because the host device in advance excludes any transaction destination incapable of the transaction for a prescribed reason, a transaction destination incapable of the transaction for the prescribed reason cannot be specified at the terminal device. This prevents cancellation of started transaction processing based on the prescribed reason, as well as restarting of transaction processing with selection of a different transaction destination. The result is smooth performance of transaction processing.

[0052]

Because this structure is arranged to display, by the transaction destination display means, the transaction capable transaction destinations transmitted from the host device, and, from among those displayed, to cause specification of a transaction destination for transaction processing, there is enabled confirmation and specification of a transaction destination at the terminal device.

[0053]

Because this structure is arranged to display transaction destinations in order from the transaction destination of the highest priority rank, there is enabled specification of a transaction destination with evaluation of this display as criteria. Accordingly, there is enabled a degree of shortening of the time related to specifying (selecting) the transaction destination, thereby allowing transaction processing to be processed more smoothly by a comparable degree.

[0054]

Moreover, by designating the transaction to be a credit transaction, there is enabled transaction processing with a plurality of credit card companies through use of a single card. The result is that the customer is not made to carry a plurality of credit cards, and customer service is thereby improved. Because there is display of a credit limit amount for each transaction capable credit card company, the customer is able to apply suitable criteria at the time of selecting a credit card company at the terminal device. Selection of the credit card company is thereby simplified.

Brief Description of the Drawings

Figure 1 is a drawing that shows the structure of a transaction processing system being an implementation mode of this invention.

Figure 2 is a drawing that shows the ID card according to the implementation mode of this invention.

Figure 3 is a drawing that shows the structure of the terminal device according to the implementation mode of this invention.

Figure 4 shows the structure of a transaction destination record according to the implementation mode of this invention.

Figure 5 is a flow chart that shows the process of the transaction processing system of this implementation mode.

Figure 6 is a flow chart that shows the new registration process of this implementation mode.

Figure 7 is a flow chart that shows the deletion process of this implementation mode.

Figure 8 is a flow chart that shows the priority rank modification process of this implementation mode.

Figure 9 is a diagram that shows an example of the display screen at the time of executing the priority rank modification process of this implementation mode.

Figure 10 is a flow chart that shows transaction processing of this implementation mode.

Figure 11 is a flow chart that shows the processing that selects the transaction destination of this implementation mode.

Figure 12 is a flow chart that shows the process for selecting a transaction destination according to another implementation mode of this invention.

Figure 13 is a diagram that shows a table format example of the terminal device at the time of selecting a transaction destination according to the implementation mode of Figure 12.

Description of the Symbols

| | |
|----|--------------------------------------|
| 1 | Terminal Device |
| 2 | Host Device |
| 5 | ID Card |
| 6 | Magnetic Strip |
| 14 | Input Device |
| 15 | Card Reader |
| 16 | Communications Component |
| 17 | Display Component |
| 18 | Printer |
| 20 | Transaction Destination File |
| 21 | Transaction Destination Record |
| 22 | ID Number Memory Area |
| 23 | Card Company Information Memory Area |
| 30 | Card Company Record |

- 31 Company Name Memory Area
- 32 Identification Code Memory Area
- 33 Encoding Data Memory Area
- 34 First Priority Rank Memory Area
- 35 Second Priority Rank Memory Area
- 36 Effective Period Memory Area
- 37 Credit Limit Amount Memory Area

Fig. 1

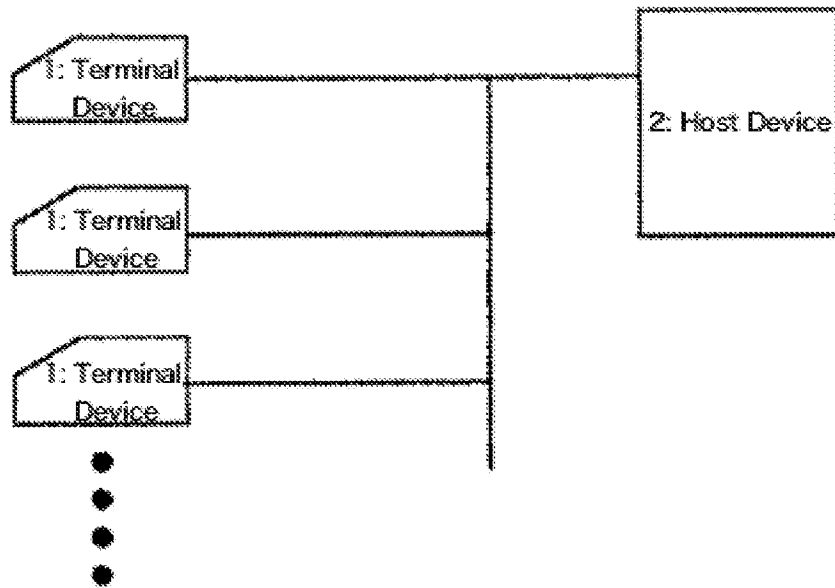

Fig. 2

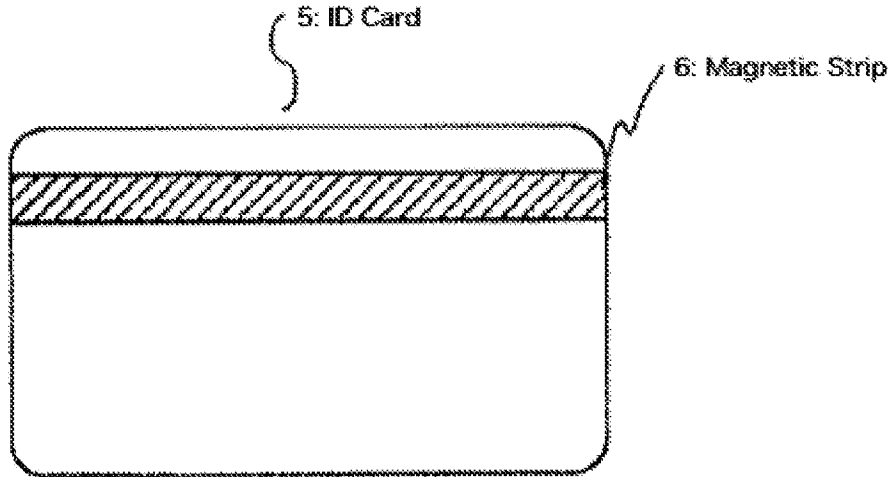

Fig. 3

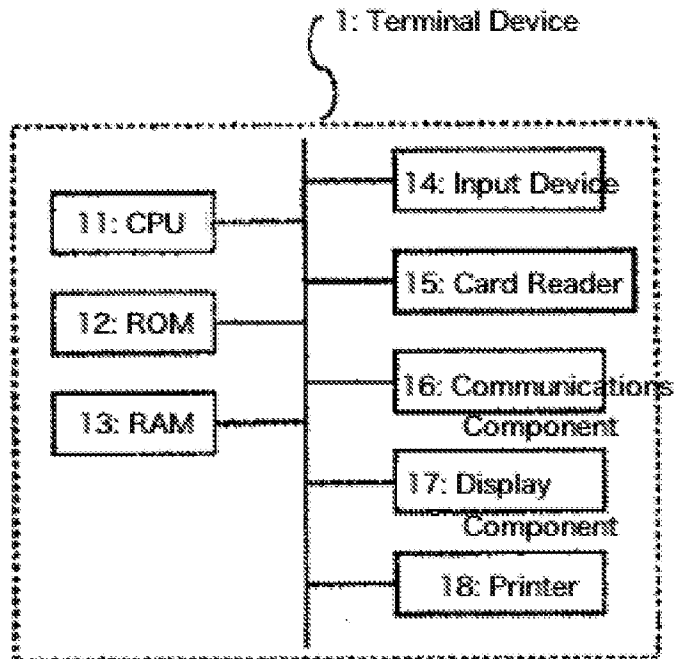

Fig. 4

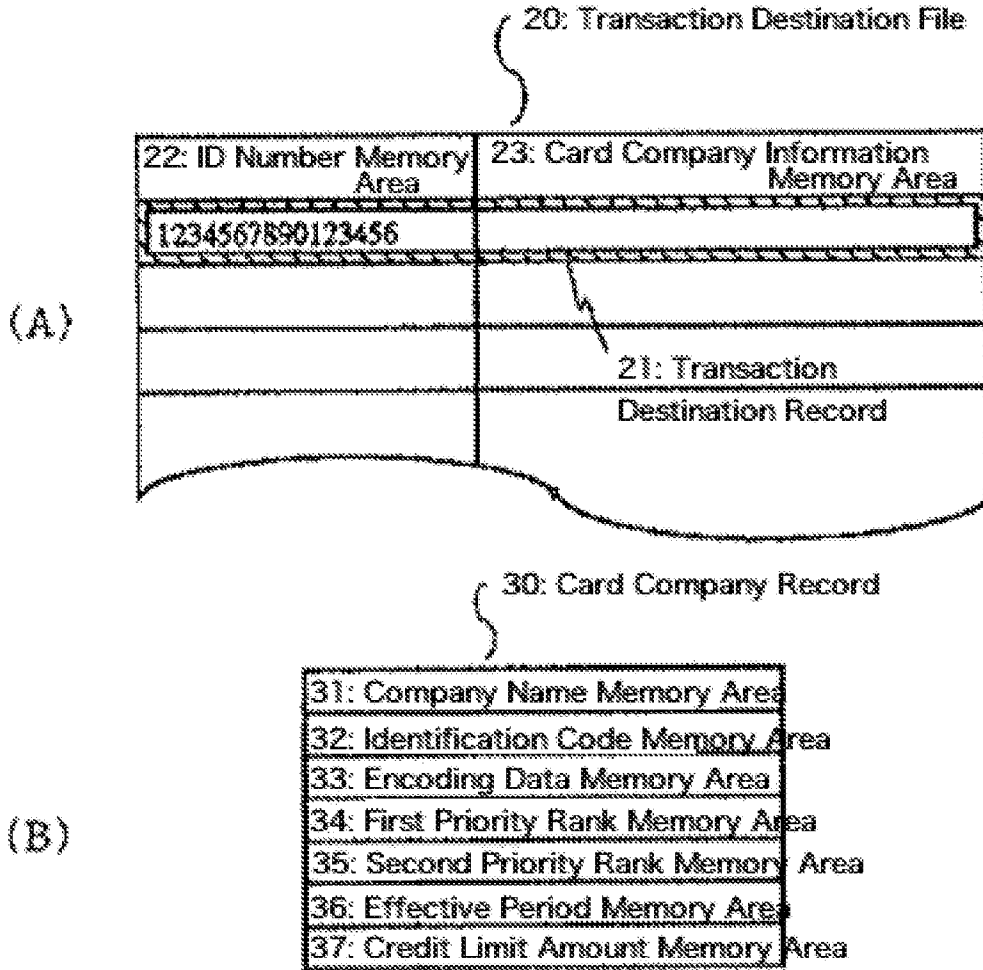

Fig. 5

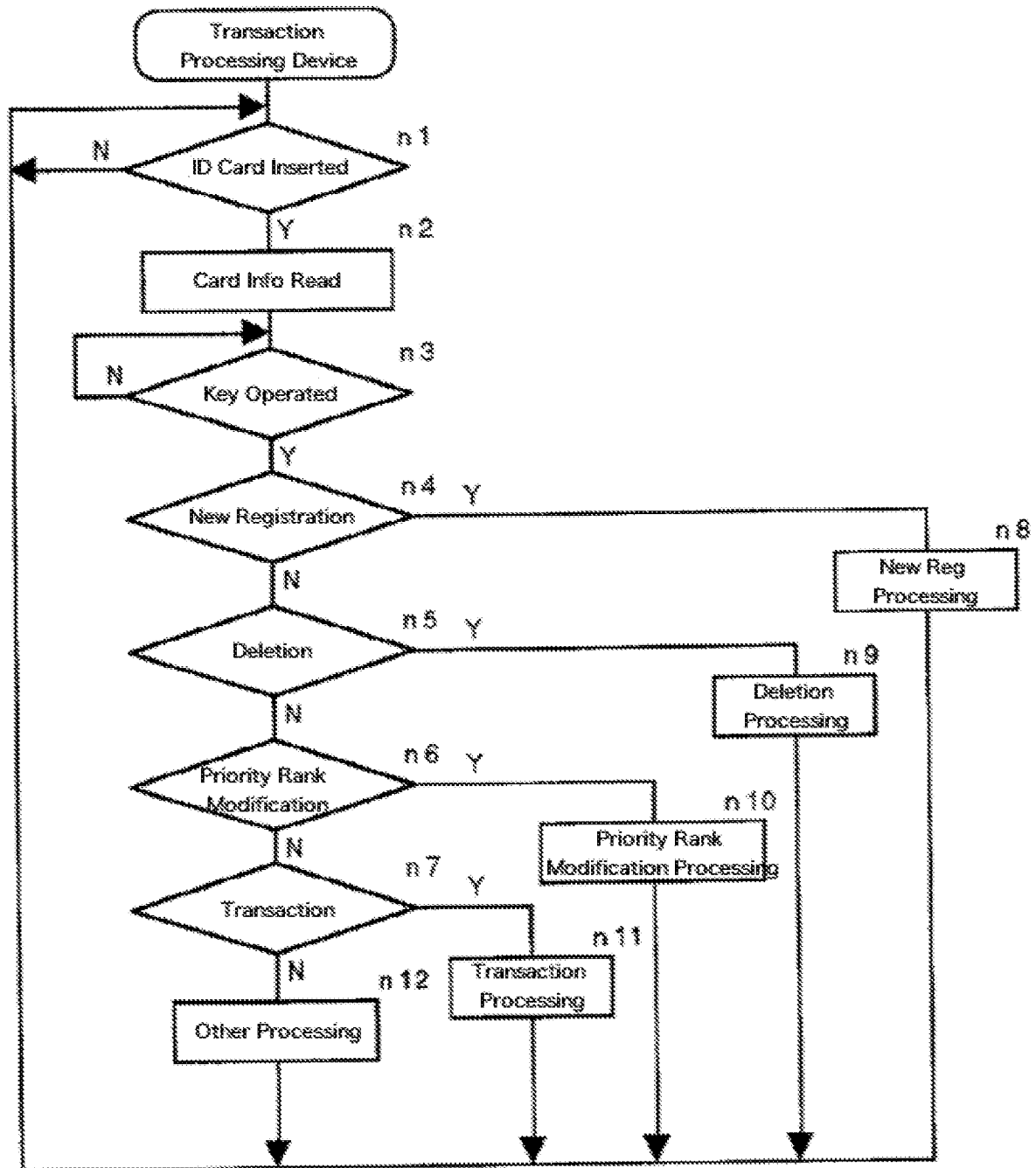

Fig. 6

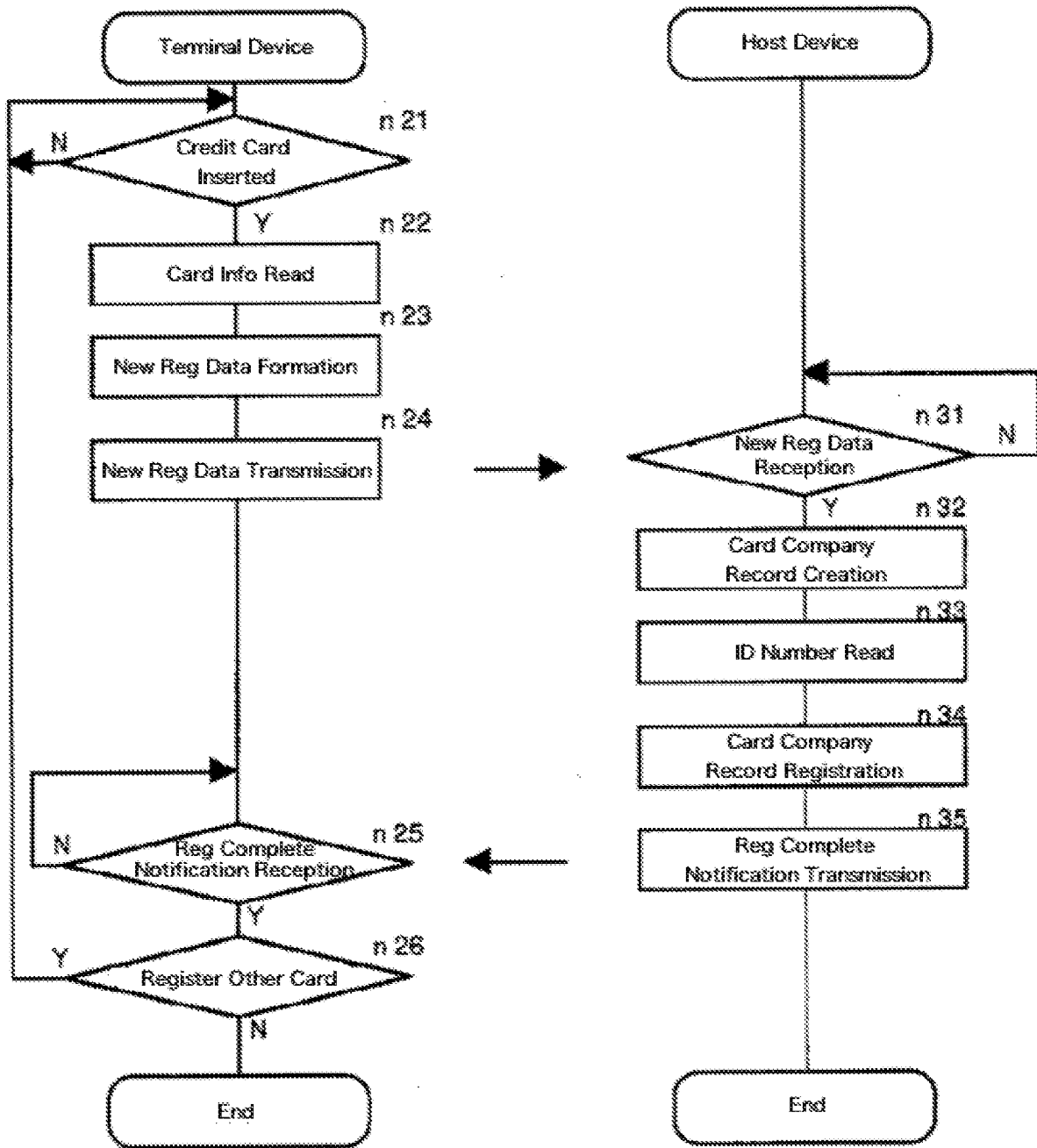

Fig. 7

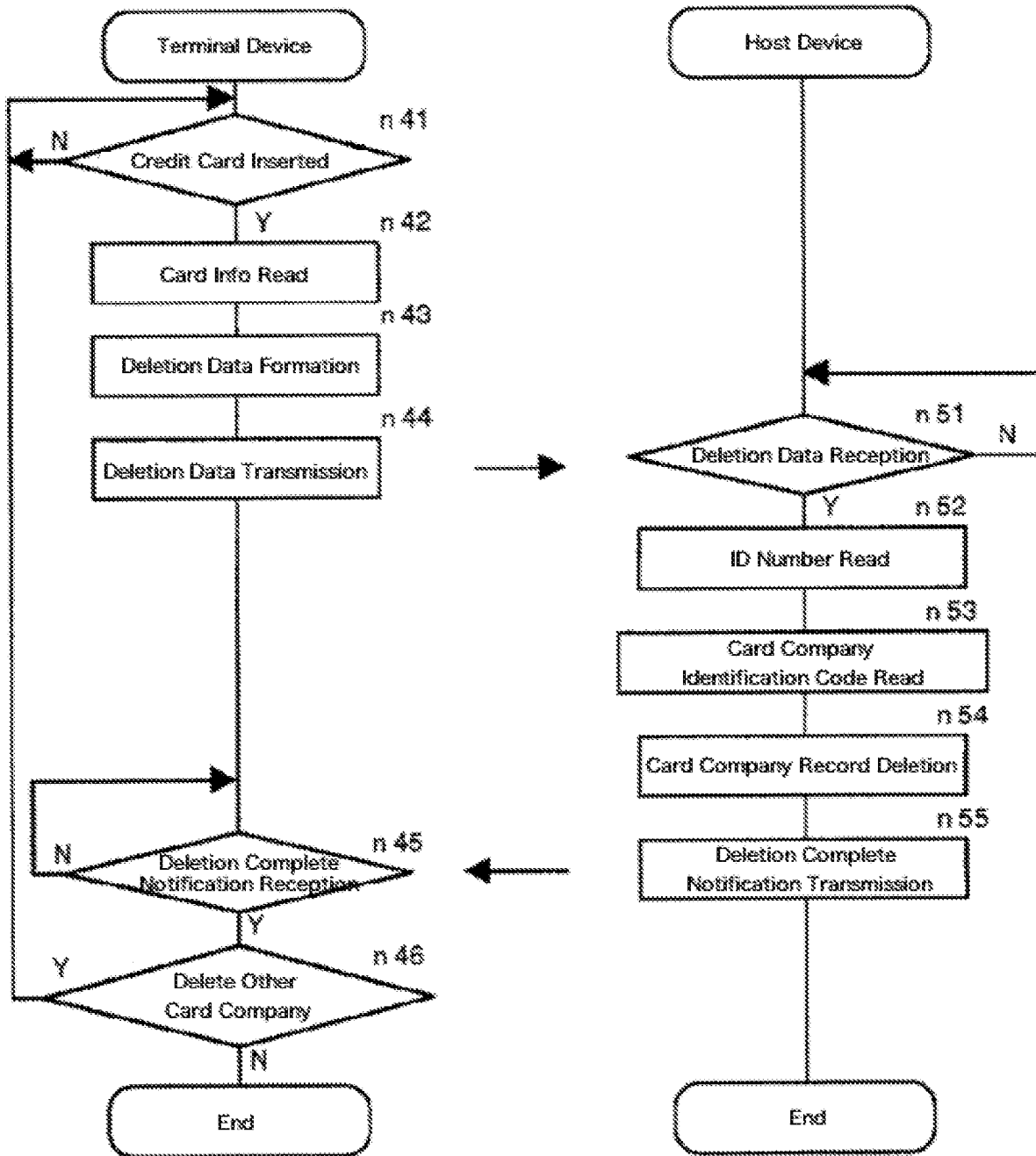

Fig. 8

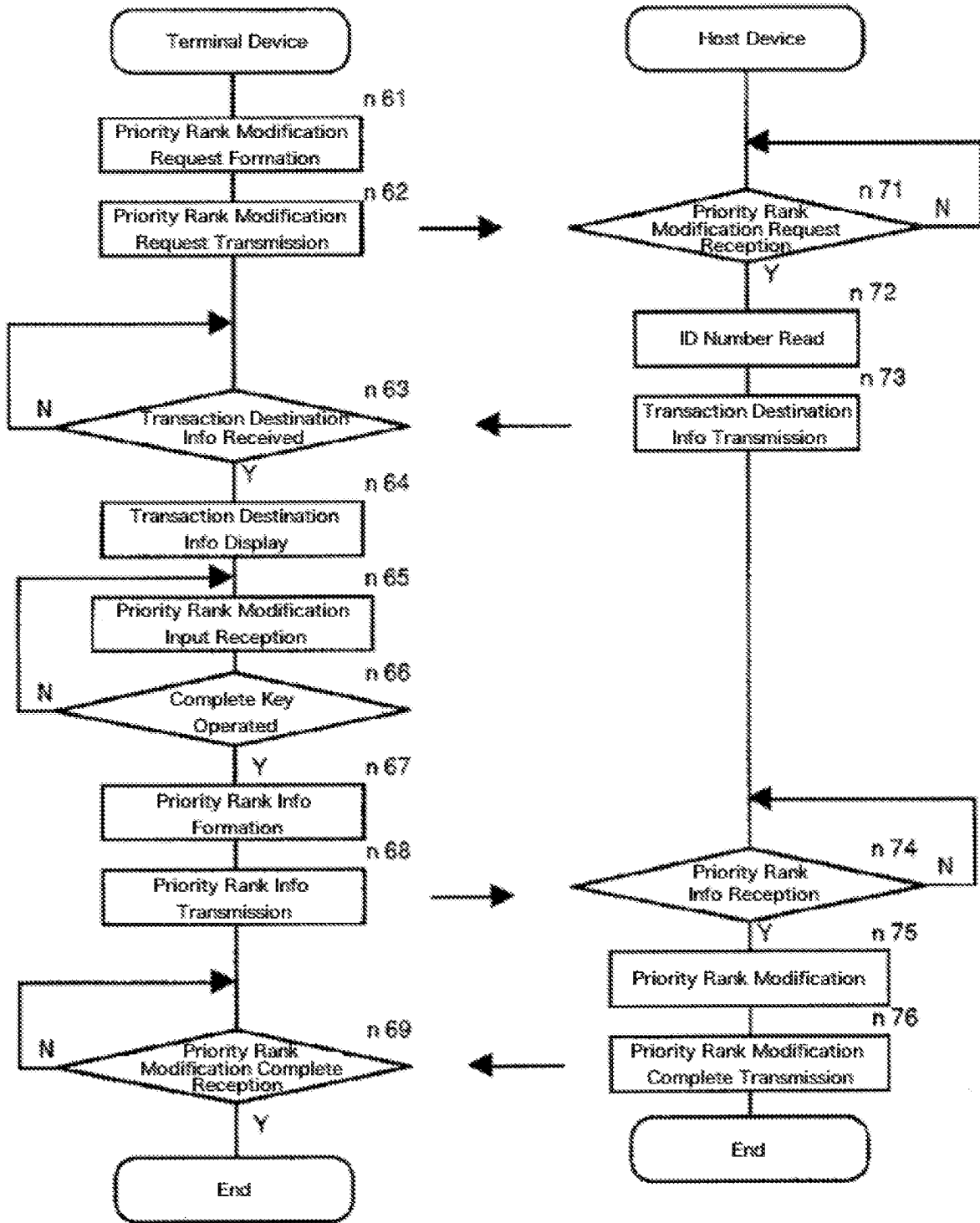

Fig. 9

| Priority Rank | Credit Card Company | Credit Limit Amt |
|---------------|---------------------|------------------|
| 1 | A B C Card | 1 0 0 (10k Yen) |
| 2 | X Y Z Card | 5 0 (10k Yen) |
| 3 | S S S Card | 3 0 (10k Yen) |
| 4 | Q Q Q Card | 1 0 0 (10k Yen) |

Move cursor and input priority rank.

Fig. 10

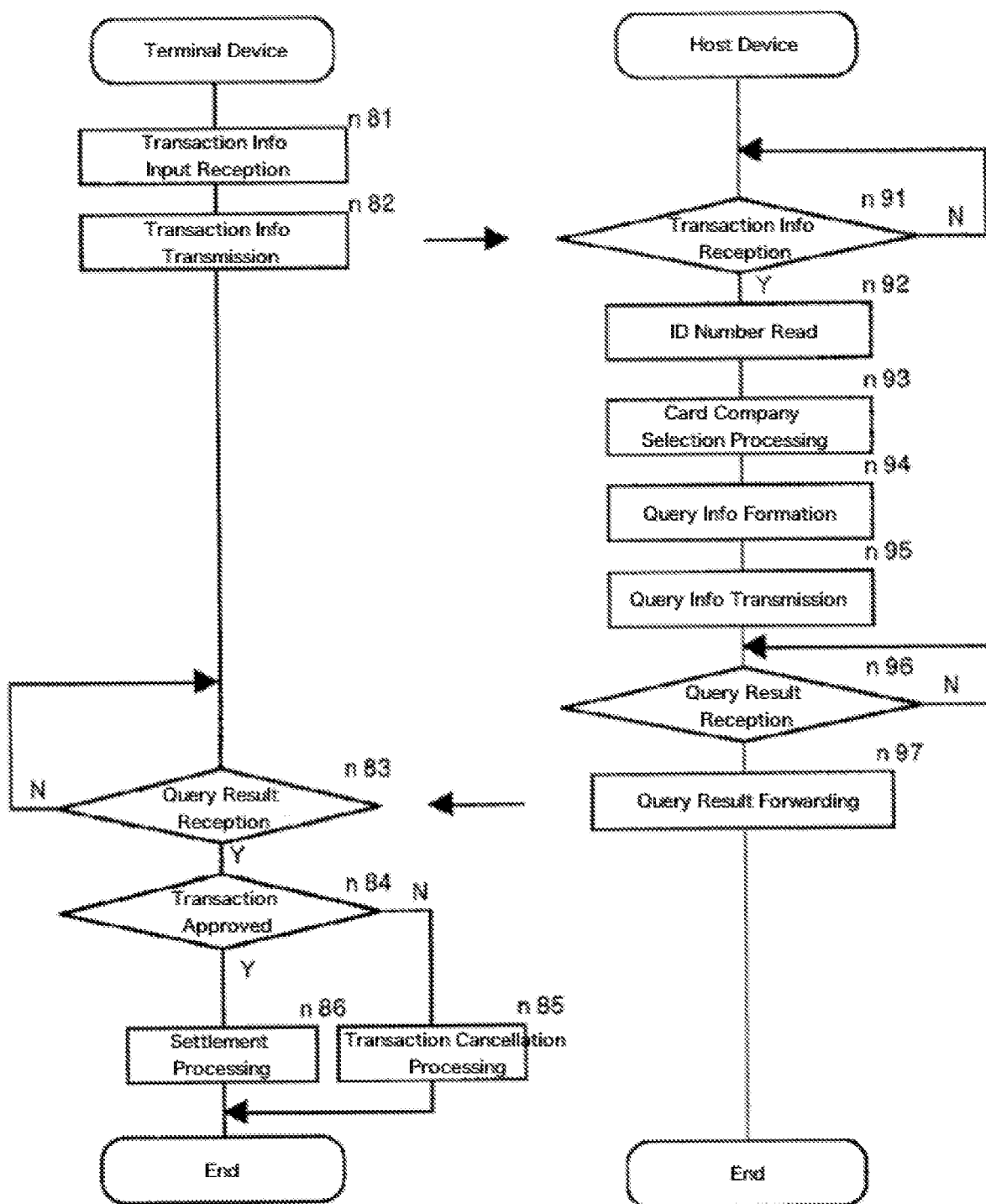

Fig. 11

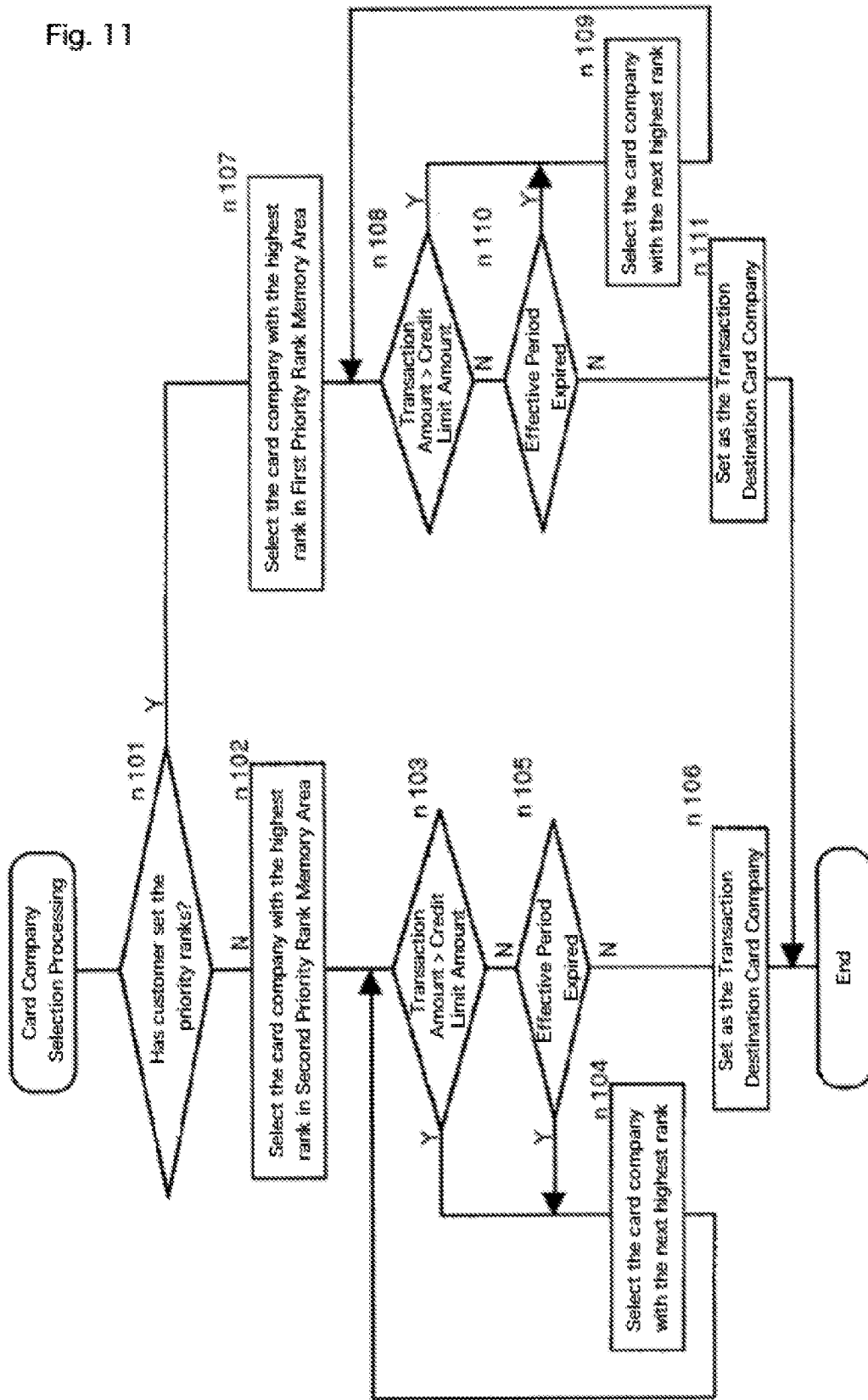

Fig. 12

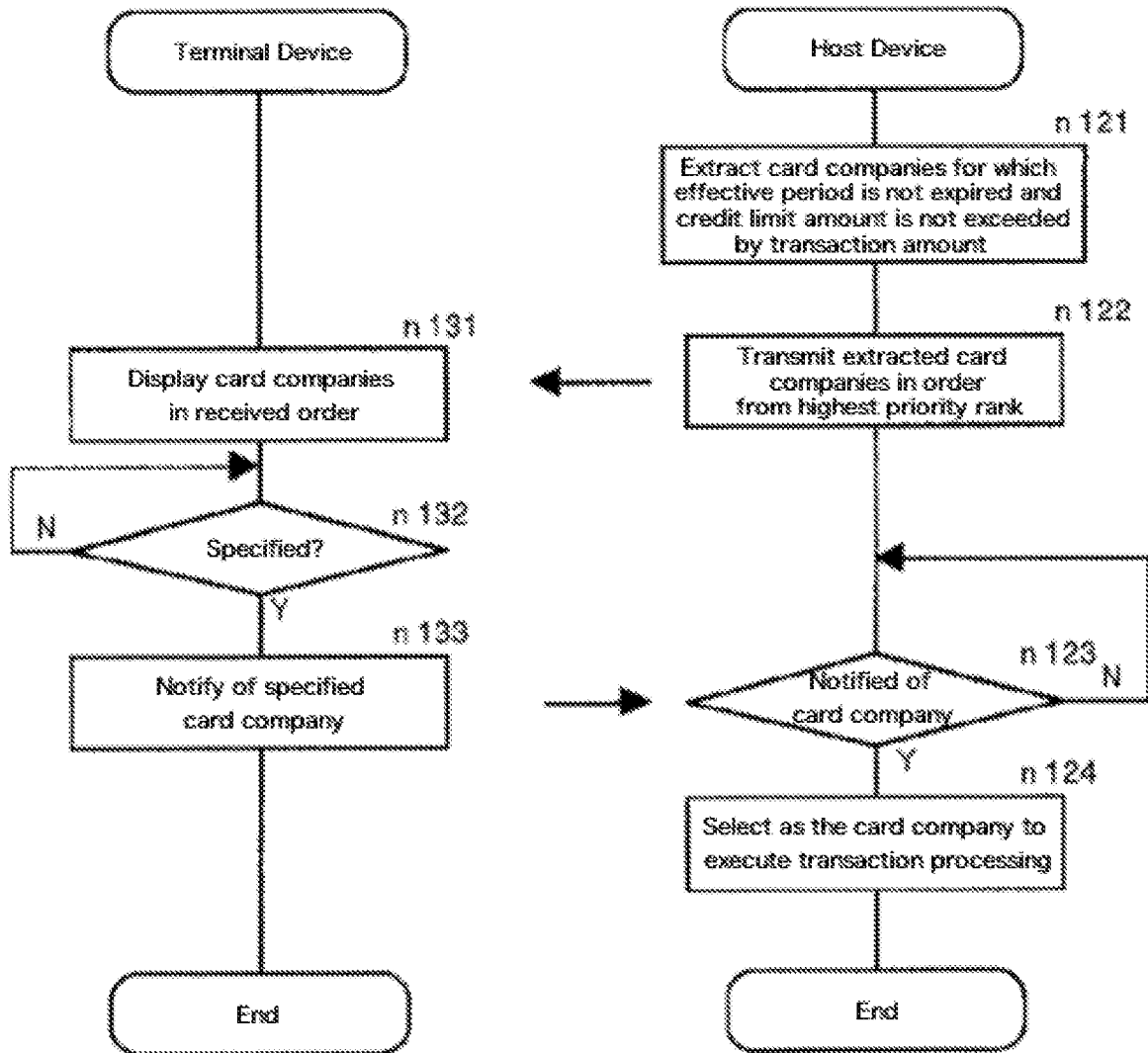

Fig. 13

| Priority Rank | Credit Card Company | Credit Limit Amt |
|---------------|---------------------|------------------|
| ■ | A B C Card | 1 0 0 (10k Yen) |
| 2 | X Y Z Card | 5 0 (10k Yen) |
| 3 | S S S Card | 3 0 (10k Yen) |
| 4 | Q Q Q Card | 1 0 0 (10k Yen) |

Move cursor and input priority rank.